



Pro SeriesTM Extended Handles

OWNERS MANUAL

MODELS: 301250 / 301252



TAKE SAFETY SERIOUSLY

This book contains important safety information.
Please read it carefully.



Your safety, and the safety of others, is very important. The proper and safe use of your Rhino® post driver and accessories is an important responsibility and should be taken seriously.

Keep this owner's manual available, so you can refer to it at any time. This owner's manual is considered a permanent part of the post driver and accessory and should remain with the post driver and accessory if resold.

The information and specifications included in this publication were in effect at the time of approval for printing. Rhino Tool Company, Inc. reserves the right, however, to discontinue or change specifications or design at any time without notice and without incurring any obligation whatever. No part of this publication may be reproduced without written permission from:

Rhino Tool Company

To help you make informed decisions about safety, you will find important safety information in a variety of forms, including:

- Safety Labels on the post driver and accessories.
- Safety Messages Preceded by a safety alert symbol and one of three signal words, DANGER, WARNING, or CAUTION. These signal words mean:



Immediate hazards that will result in severe personal injury or death.



Hazards or unsafe practices that could result in personal injury.



Hazards or unsafe practices that could result in injury, product or property damage.

- Safety Headings such as IMPORTANT SAFETY INFORMATION.
- Safety Section such as POST DRIVER SAFETY.
- Instructions how to use this post driver correctly and safely.

CONTENTS

Section	Page
Safety Symbol Description	i
Table of Contents	1
Introduction	2
Rhino® Pro-Series™ Post Driver and Extended Handle Safety	3
Rhino® Pro-Series™ Post Driver and Extended Handle Operating Instructions	6
Starting the Engine	7
Hot Restart	8
Driving a Post	8
Installing a Chuck Adapter	9
Installing an Alternative Chuck	10
Multi-Pro™ Maintenance	10
Rhino® Pro-Series™ Post Driver and Extended Handle Installation	12
Rhino® Pro-Series™ Post Driver and Extended Handle Parts & Accessories List	18
Limited Warranty and Registration	20
Troubleshooting	21

INTRODUCTION

Congratulations on your selection of the Rhino® Pro-Series™ Post Driver Extended Handles. We are certain that you will be pleased with your purchase. This post driver was built with the Honda GX35 engine. Honda supplies its own owner's manual that covers all the operator and service issues associated with the Honda engine. Please read this manual as closely as you do the Rhino manual. The success that you experience with this tool is dependent upon your knowledge and understanding of how to properly operate and care for the Honda engine installed on your new post driver and proper use of the extended handles.

As you read this manual, you will find information preceded by a NOTE symbol. That information is intended to help you avoid damage to your post driver, post driver accessories, other property, or the environment.

We suggest you read the warranty information fully and understand its coverage and your responsibilities of ownership. Fill out the warranty registration card or online registration to receive Rhino® Limited Lifetime Impact Warranty. (See Page 24) Please read and understand the Honda warranty policy. The Honda warranty is separate from the Rhino® warranty and is subject to its own coverage conditions and responsibility requirements. The warranty is a separate document and is included with the Honda owner's manual.

When your Rhino® post driver needs scheduled maintenance, the technical service staff here at Rhino Tool Company is standing by to assist you. Our fully trained staff can ensure that you receive the correct service kit or direct you to the nearest Rhino Servicing Dealer.

The engine requires scheduled maintenance, keep in mind that your Honda service dealer is fully equipped and specially trained in servicing the Honda engine. Your Honda servicing dealer is dedicated to your satisfaction, and will be pleased to answer your questions and concerns.

Kindest Regards,
The Rhino Tool Team



POST DRIVER & EXTENDED HANDLE SAFETY

IMPORTANT SAFETY INFORMATION

The Rhino® Pro-Series™ gas powered drivers are designed to drive fence post, ground rod, delineator post, grape stake, form pin, tent stake and other like items into the ground depending on the Pro-Series model used for post driving.

 **CAUTION** Uses, other than those intended, can result in injury to the operator as well as those around the operator. Damage to the driver, extended handles and to the surrounding area may result as well.

This post driver, and extended handles, are intended for use by professional installers. Never allow children to operate this tool.

Most accidents can be prevented if you follow all instructions in this manual, on the post driver, and on the extended handles. The most common hazards are discussed below, along with the best method to protect yourself and others.

 **WARNING** **UNDERGROUND UTILITIES:** Driving a post into an underground utility can be

EXTREMELY DANGEROUS, exposing the operator and those around to potentially life threatening danger. Damage to surrounding property can also occur as a result of a post being driven into an underground utility. Be absolutely certain that you are aware of all underground utilities in the area in which you intend to drive posts. Ensure that a certified locating service has identified all underground utilities prior to beginning your project. Failure to do so can be catastrophic. Underground utilities include but are not limited to: Electric, Gas, Telephone, Water, Sewer, TV Cable, Lawn Sprinklers, etc.

 **WARNING** **POWER LINES:** DO NOT use the post driver with the extended handle attachment near any overhead obstructions such as electrical, cable, or telephone lines. Maintain a minimum clearance of 10 feet (3 meters) from all power lines.

 **WARNING** **GASOLINE:** Gasoline is **HIGHLY FLAMMABLE** and **EXPLOSIVE**. You

can be burned or seriously injured when handling fuel.

 **WARNING** **EXHAUST:** The exhaust from the engine contains poisonous carbon monoxide gas that can build up to dangerous levels in closed areas. Breathing carbon monoxide can cause unconsciousness or death. Never run the engine in a closed or even partly closed area where people may be present.

 **WARNING** The engine exhaust from this product contains chemicals known to the State of California to cause cancer, birth defects or other reproductive harm.

 **WARNING** **ENGINE MAINTENANCE:** Improperly maintaining the engine on this power tool, or failure to correct a problem before operation, can cause a malfunction in which you can be seriously hurt or killed. In accordance with the engine owner's manual, always perform a pre-operation inspection of the engine before each use and correct any problem.

 **WARNING** **DRIVER MAINTENANCE:**

Improperly maintaining the driving mechanism on this power tool, or failure to correct a problem before operation, can cause a malfunction in which you can be seriously hurt or killed.

In accordance with this manual, always perform a pre-operation inspection of the driving mechanism before each use and correct any problem.

 **WARNING** **DO NOT** lend or rent your post driver without the instruction manuals. Be sure that anyone using it understands the information contained in these manuals.

 **WARNING** **DO NOT** use this post driver for any purpose other than driving posts into the ground. Misuse may result in personal injury or property damage, including damage to the machine

 **WARNING** Minors should never be allowed to use this

power tool. Bystanders, especially children, and animals should not be allowed in the area where it is in use.

 **WARNING** **NEVER** let your power tool run unattended. When it is not in use, shut it off and make sure that unauthorized persons do not use it.

 **WARNING** **DO NOT** operate this post driver unless the operator is wearing safety glasses, safety shoes, hearing protection, gloves or any other safety equipment advised by, ANSI, NIOSH, OSHA, or any other safety regulatory agency, the employer or the owner of this post driver.

Hearing protection is required as the post driver emits noise at 100 dB level. Bystanders should, at a minimum, wear safety glasses and hearing protection while in the presence of this power tool during operation. If not wearing protective gear, bystanders should keep a distance of 50 feet (15 m) from the post driver while in

operation.

Prolonged use of a power tool (or other machines) exposing the operator to vibrations may produce white finger disease (Raynaud's phenomenon) or carpal tunnel syndrome. These conditions reduce the hand's ability to feel and regulate temperature, produce numbness and burning sensations and may cause nerve and circulation damage and tissue necrosis.

Not all factors contributing to white finger disease are known, but cold weather, smoking and diseases or physical conditions that affect blood vessels and blood transport, as well as high vibration levels and long periods of exposure to vibration are mentioned as factors in the development of white finger disease.

In order to reduce the risk of white finger disease and carpal tunnel syndrome, please note the following:

- This Pro-Series™ post driver has been designed with Rhino® CIS™ anti-vibration handles to reduce the transmission

POST DRIVER & EXTENDED HANDLE SAFETY

of vibrations created by the machine to the operator's hands. An anti-vibration system is recommended for those persons using power tools on a regular or sustained basis.

- The handle opposite the throttle handle has been fitted with an EPDM foam grip further dampening vibrations.
- Wear gloves and keep your hands warm.
- Ensure that the EPDM foam and the spring dampening system are in good working condition.
- Ensure the post driver has no loose components. Loose components lead to high vibration levels.
- Maintain a firm grip at all times, but do not squeeze the handles with constant, excessive pressure. Take frequent breaks.

All of the above mentioned precautions do not guarantee that you will not sustain white finger disease or carpal tunnel syndrome. Therefore, continual and regular users should closely monitor the condi-

tion of their hands and fingers. If any of the above symptoms appear, seek medical advice immediately.



DO NOT modify this power tool in any way.



DO NOT put anything other than a post into the chuck on the driver.



DO NOT operate your post driver unless it is on a post to be driven. Operation of the driver without it driving on a post could damage the power tool.



SURROUNDINGS:
This power tool emits noise at 100 Db, which may be disturbing to animals and livestock. Ensure prior to operation, that any livestock are cleared from the operational area to prevent a situation in which startled livestock become a safety hazard.

WARNING LABELS

If any of your post driver or extended handle's warning labels are marred or

IMPORTANT SAFETY INFORMATION

destroyed, replace it immediately. Please send a request indicating which label is needed, and Rhino Tool Company will send you a new warning label at no expense to you.

End of Life Cycle

When your Rhino® gas powered driver is coming to the end of its life cycle, destruction of the unit should to be conducted according to international and local environmental regulations.

The gas powered post driver contains:

- Fuel
- Oil
- Grease
- Electric components
- Plastic-steel and aluminum components.

POST DRIVER & EXTENDED HANDLE OPERATING INSTRUCTIONS

Your Rhino® Pro-Series™ Gas Powered Driver is an efficient and effective power tool designed and developed to tackle a difficult and time consuming task; driving posts. The extended handle accessory is intended to make driving tall posts easier. Safe operating practices must be followed while operating the post driver with the

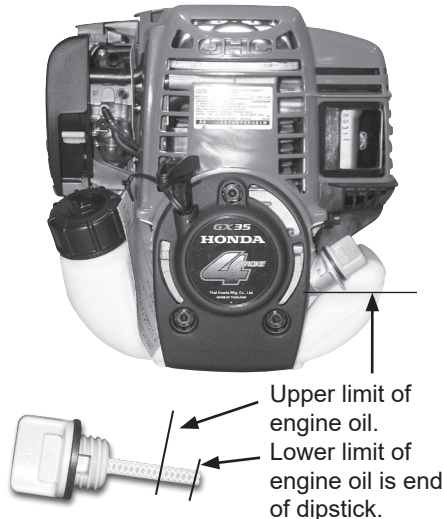

Fig. 1

extended handles. It is very important to understand that your post driver is a very powerful machine; it has to be to do the very difficult job it is designed to perform. You must read and understand your post driver and extended handle operating instructions before using the post driver. It is also very important that you make sure all operators are trained to operate your post driver safely with the extended handle attachment. If you or any operator doesn't understand any of the instructions in this manual, call Rhino Tool Company at 866-707-1808 or 309-853-5555 and we will assist you with any questions you may have about using the unit.

⚠ WARNING AVOID SERIOUS INJURY OR DEATH
READ THIS MANUAL BEFORE USING YOUR POST DRIVER

Visually inspect your Multi-Pro™ Post Driver before use. The interior of the chuck tube should be checked for obstructions, damage or wear to the chuck tube and anvil inside. The outer surfaces of the

driver should also be inspected for any defects. Do not use the Multi-Pro™ if there is any damage or wear until the damage or wear is corrected and repaired.

Check all fluid levels, i.e. engine oil and fuel and fill as needed as per manufacturer's specifications. (Fig. 1)

NOTE Proper oil level is essential to the operation of the post driver. Overfilling of the oil will result in loss of power and may cause permanent damage to the engine.

⚠ WARNING USE ALL RECOMMENDED SAFETY EQUIPMENT.

Rest the driver on a solid surface, i.e. tailgate, bench, or clear, solid ground and posture your body in a safe position. DO NOT start the driver anywhere but an open, well-ventilated area. It is recommended that the Multi-Pro™ only be used outdoors and never inside an enclosed building.

POST DRIVER & EXTENDED HANDLE OPERATING INSTRUCTIONS

Starting the Engine:

To start a COLD engine, move the choke lever to the CLOSED position (**Fig. 3**). Lock the throttle into high idle position. (**Fig. 2**) This is done by depressing the trigger and the high idle lock simultaneously. The throttle is now in the high idle position.

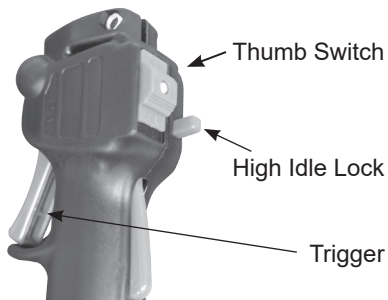

Fig. 2

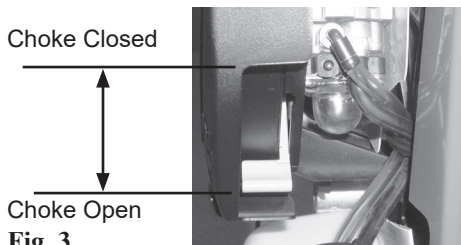

Fig. 3

To start a WARM engine, leave the choke lever in the OPEN position and do not lock the throttle into the high idle position.

Press the priming bulb repeatedly (**Fig. 4**) until fuel can be seen in the clear-plastic fuel return tube.

Slide thumb switch on throttle handle down or into the ON position.

Grasp the starter grip lightly until you feel resistance, then pull briskly in the direction of the arrow as shown in **Fig. 5**. Return the starter grip gently.

CAUTION Do not extend the starter rope to its full length as it can cause

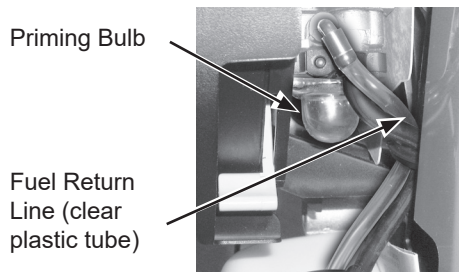

Fig. 4

damage the recoil mechanism.

CAUTION An operator should never wrap the starter rope around their hand. This will cause serious injury.

NOTE Do not allow the starter grip to snap back against the engine. Return it gently to prevent damage to the starter.

If the choke lever was moved to the CLOSED position to start the engine, gradually move it to the open position as the engine warms up. As the engine warms up also release the high idle lock



Fig. 5

POST DRIVER & EXTENDED HANDLE OPERATING INSTRUCTIONS

by slightly depressing the trigger and then immediately releasing it. Use caution as to not engage the clutch.

Hot Restart

If the engine is operated at higher ambient temperatures, then turned off and allowed to sit for a short time, it may not restart on the first pull. If necessary, use the following procedure:

Failure to follow instructions can result in personal injury



WARNING

**IMPORTANT
SAFETY
PRECAUTION**

Turn the engine switch to the **OFF** position before performing the following procedure. This will prevent the engine from starting and running at maximum speed when the throttle is in the **MAX.** speed position. If the engine starts with the throttle in the **MAX.** speed position, the post driver will operate at maximum power. This may result in **personal injury** and damage to the post driver.

1. Turn the engine switch on the post driver to the **OFF** position.
2. Move the choke lever to the **OPEN** position.
3. Hold the throttle in the **MAX** speed position.
4. Pull the starter grip 3 to 5 times.

Follow the **STARTING THE ENGINE** procedure on the previous page and start the engine with the choke lever in the **OPEN** position.

Driving a Post

Holding the post driver with your left hand on the foam grip and your right hand on the throttle will position the driver to

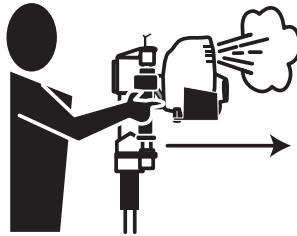

Fig. 6

direct the engine exhaust away from the operator (**Fig 6**). (See Exhaust Warning) Insert a post into the Multi-Pro™ making sure the end of the post to be driven is in the correct location on the ground. (**Fig. 7**) Position the driver aligned centered to the post. If not aligned properly, damage could be caused to the driver or the post.

Apply steady downward pressure to the handles and apply enough throttle to engage the clutch and hammer.

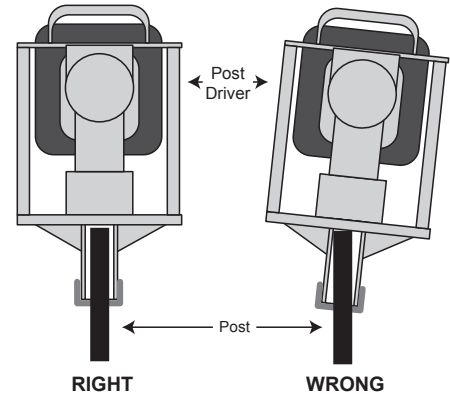

Fig. 7

POST DRIVER & EXTENDED HANDLE OPERATING INSTRUCTIONS

Once you are confident that the post is driving straight, apply full throttle to the driver until the post is driven to the desired depth.

Release the trigger dropping the engine RPM back to idle before removing from the post. When the engine has returned to idle, proceed to the next post repeating the previous method of driving a post.

Installing a Chuck Adapter

WARNING **CHUCK SIZE:** A chuck or chuck adapter that is too large for the post being driven may damage the driver and may damage the end of the post. Using the appropriate chuck or chuck with adapter will align the post to optimum striking position and prevent damage to the driver. See the chart in the operating manual that came with your post driver to specify the appropriate adapter for your application. Chucks and chuck adapters wear out and should be replaced as needed. Inspect your driver's chuck and chuck adapters frequently.

Some Pro-Series™ drivers are equipped with the Rhino® Chuck-Lok™ Adapter System. It is comprised of the master chuck, the locking nut and two-piece adapters.

WARNING **ALWAYS HAVE THE LOCKING NUT IN PLACE WHEN DRIVING POSTS:** The Chuck-Lok™ locking nut should always be tightened onto the master chuck to protect the chuck threads, even when

not using an adapter. Failure to do so exposes the chuck to possible damage.

The two-piece adapter design is a solution for the occasional flared post. Should a post flare and lodge inside the chuck when using the adapter, in most cases the operator can loosen the locking nut letting it slide down the post, then lift the driver off the post. The operator can quickly re-insert the adapter, secure them with the locking nut and resume driving posts.

See **Fig. 8** for steps for installing Chuck-Lok™ adapters.

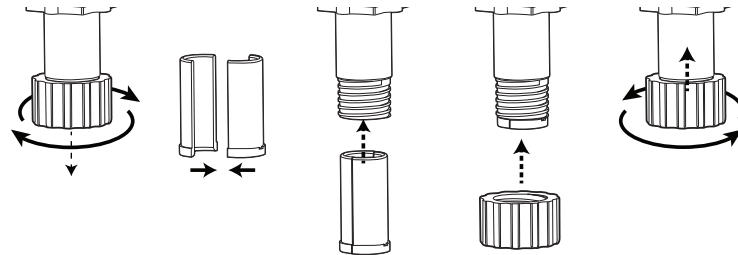

Fig. 8 - Hand tighten ONLY. No Tools.

POST DRIVER & EXTENDED HANDLE OPERATING INSTRUCTIONS

Installing an Alternative Chuck

Some of the Pro-Series™ drivers have a quick change design that allows the operator to quickly remove the standard master chuck and install an alternative chuck configuration for the post driving application. Please refer to the manual that came with your Pro-Series™ post driver model for instructions on changing the standard master chuck. If you need a chuck option for a specific post, contact your Rhino Tool Company representative to inquire if there is an option available.

 **WARNING** NEVER REFUEL WITH THE ENGINE

HOT OR RUNNING: Never refuel your Multi-Pro™ with the engine hot or running as there is a possibility the flammable fumes from the gasoline can ignite, causing severe injury and/or damage to your Multi-Pro™ and surrounding area. Follow engine manufacturer's instructions for the refueling of the engine.

 **WARNING** DO NOT OPEN CRANKCASE COVER WHILE ENGINE IS RUNNING.

With each use check the engine oil level, air filter, and all fasteners. If necessary, add oil, clean or replace the air filter and tighten any loose nuts, bolts, or any other fastener. (See page 6 for engine oil level)

Change engine oil as per engine manufacturer's specifications. Dispose of used oil in accordance with any local, state, or federal regulations.

Refer to the Service Instructions that came with your post driver for more details regarding proper maintenance.

Following the service requirements for the Pro-Series™ will insure years of trouble free post driving. Always refer to the Honda GX35 manual for maintenance and service on the engine. The following instructions are for the Rhino® Pro-Series™ Extended Handle accessory only.

 **WARNING** NEVER SERVICE WITH ENGINE HOT OR RUNNING

Before any service is performed, remove the spark plug wire from the spark plug and ground it to the engine body to prevent any accidental start-up of the engine.

Empty all fuel and oil from the engine as specified by the Honda GX35 manual that came with your Rhino® Pro-Series™ post driver before beginning any installation or servicing of your post driver. Please responsibly discard any oil or fuel that will not be reused.

Rhino® Pro-Series™ Extended Handles require assembly and installation. Inspect the product carefully when unpacking to make sure no breakage or damage occurred during shipping. Do not assemble or operate this accessory if any parts are damaged or missing. Call 1-866-707-1808 for assistance with replacement parts.

POST DRIVER & EXTENDED HANDLE OPERATING INSTRUCTIONS



WARNING

DRESS PROPERLY

When operating the post driver with the Rhino® Pro-Series™ Extended Handles wear a hard hat, boots and gloves. Wear eye and hearing protection.



WARNING

KEEP BYSTANDERS AT A SAFE DISTANCE

Keep all bystanders at least 50 ft (15 m) from the operating area during usage. Keep animals and children away from the area when using the extended handles.



WARNING

MAINTAIN BALANCE

When operating the post driver with the extended handle accessory, lay all posts down on the ground and insert into the post driver master chuck from the side. Once the post is inserted have another operator guide the post to a standing position, while the other operator raises the post driver by firmly holding the extended handles with both

hands until the post driver and the post are in a vertical position. It is important to lift properly with the knees, maintain good footing, proper grip and stance. Be sure the operator running the post driver is capable of lifting a minimum weight of 45 lbs. Avoid all usage which the operator feels to be beyond their capability. One operator will continue to hold the post in place until the other operator has driven the post securely into the ground.

When removing the driver from the post, make sure both hands are firmly on both side handles. Lift with the knees with feet firmly planted shoulder width apart to maintain stability. Keep elbows bent and close to the body while lifting the driver. Never swing or reach too far with the post driver while it is being used with the extended handle accessory. Using the post driver with extended handles while standing on ladders, lifts or other raised, unsecured surfaces is not advised.



WARNING

The design of the Rhino® Pro-Series™

Extended Handles should not be modified without the permission of the manufacturer. Always use genuine Rhino® Pro-Series™ Accessories. Non-authorized modifications and/or accessories can result in serious personal injury to the operator or others.

IMPORTANT

GENERAL MAINTENANCE

All Rhino® Pro-Series™ Post Drivers and Accessories should be maintained and repaired by qualified technicians using identical replacement parts. If you notice any bent or broken parts on your post driver or extended handles, contact your local dealer or Rhino Tool Company to order replacement parts. Do not operate with damaged or missing parts. Visit www.rhinotool.com to locate your nearest dealer or contact customer service.

INSTALLATION INSTRUCTIONS

Installation of Rhino® Pro-Series™ Extended Handles:

1. Loosen the two HEX bolts (4 mm Hex Wrench) on the throttle.

Do Not Remove Them.

2. Remove the air filter cover on the Honda GX35 engine. Using two 10mm wrenches loosen the throttle cable retaining nuts.

3. Disengage the throttle cable from the carburetor throttle control linkage.

4. Cut the wire ties holding the wire to the throttle cable and disconnect the wire harness.

5. Mark the top side of the handle collars with a black marker or alike as they are specific on which way they are installed.

6. Remove the two 5/16" Socket Head Cap Screws (1/4" HEX wrench) recessed in the top handle assembly.



CAUTION

The handle collars are under tension from the handle springs and could cause injury from recoil.

7. Remove the two 5/16" Socket Head Cap Screws (1/4" HEX wrench) recessed in the lower handle assembly.

NOTE

If you have an earlier model that does not have a removable lower handle assembly you will need to remove the four 5/16" HEX bolts (1/4" wrench) in the top handle bracket and set aside to allow the throttle to be removed from the side handle assembly. * **Please note you will need to order a lower handle (Part no. 301233) if your Pro-Series Driver model does NOT already have one. DO NOT OPERATE EXTENDED HANDLES WITHOUT A CONNECTING LOWER HANDLE.**

8. Slide the side handle assembly down removing the throttle as it is slid through the lower body.

9. Using a 1/4" Socket remove the ground screw. Retain the ground screw to be reused when re-assembling.

10. Coat the 5/16" Socket Head Cap Screws (see step 7) with Loctite Primer 7649 and allow to dry. Use the new screws provided with the extended handle accessory, do not use the original screws from the handles as they may have wear on the threads.

11. Spray Loctite Primer 7649 on the bolt holes at the end of the side handle.

12. Insert the side handle through the lower and upper handle assembly, noting the previous marks, you made, indicating where the handle collars should be installed. Insert the 5/16" Socket Head Cap Screws into the recess in the top handle assembly.

13. Insert the 5/16" Socket Head Cap Screws into the recess in the bottom handle assembly.

INSTALLATION INSTRUCTIONS

Step 1



Step 2



Step 3



Step 4

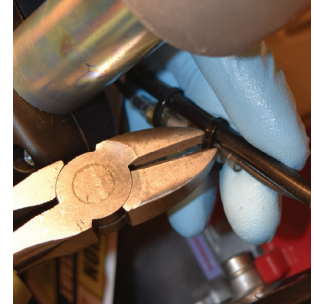

Step 5



Step 6



Step 7



Step 8



INSTALLATION INSTRUCTIONS

Step 9



Step 10



Step 11



Step 12

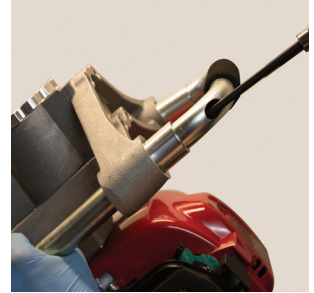

Step 13



Step 14

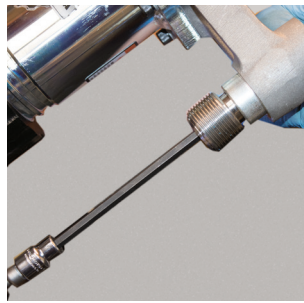

Step 15

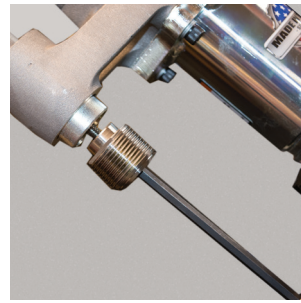

Step 16



INSTALLATION INSTRUCTIONS

Step 17



Step 18

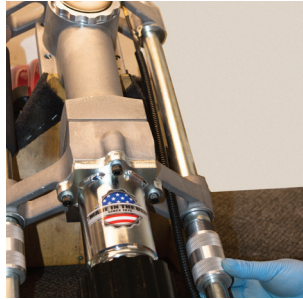

Step 19



Step 20

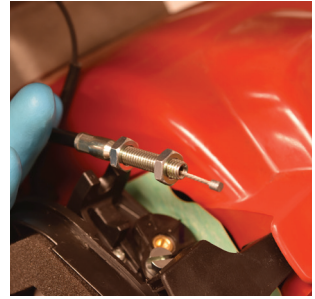

Step 21



Step 22

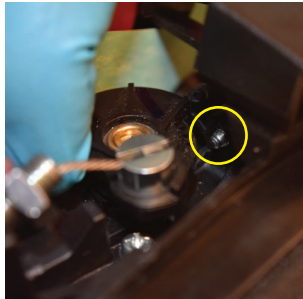

Set screw circled above.

Step 23

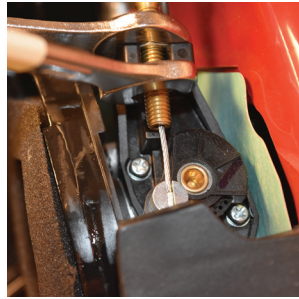

Step 24



INSTALLATION INSTRUCTIONS

14. Tighten 5/16" Socket Head Cap Screws into the recess in the bottom handle assembly, one screw in each side of the bottom handle.

15. See Step 14 above.

16. Slide the left side Handle Collar over the threaded extended handle adapter and hand tighten.

17. Thread the throttle cable extension through the right side of the lower handle assembly.

18. Run throttle cable extension along the side of the body assembly.

19. Bring enough cable extension through the top handle assembly to attach the throttle linkage to the engine.

20-24. Locate the throttle adjuster nuts and spin the inner nut all the way to the rear of the threads and spin the outer nut so that

there is still 3-5 threads showing. Install the throttle cable end into the carburetors throttle control linkage. **Making sure that the throttle linkage is contacting the set screw.** Spin both adjuster nuts towards the throttle adjustment bracket till they are snug. Check that the throttle control linkage is still in contact with the set screw. Using two 10mm wrenches hand tighten the adjuster nuts. Activate the throttle, making sure that the throttle linkage contacts the stop when fully depressed. Loosen nuts and readjust if needed.

**Note: The top throttle has been pre-adjusted with factory settings, after installation the throttle may need to be adjusted slightly for proper idle and operation.*

25. Place the ground screw through the opening in the cable clamp along with the eyelet wire on the wire harness, making sure the eyelet wire makes contact with the main body and is not inside of or on top of the cable clamp. Use a 1/4" socket

and reinstall the ground screw.

26. Locate the single wire harness (female bullet connector) coming from the Honda GX35 engine, connect it to the male bullet connector on the wire harness used in the previous step. Make sure that the connectors snap together.

27. Using a wire tie supplied with the kit, loop the first wire tie around both wire harness wires as well as the throttle cable coming from the upper throttle. With the remaining two wire ties loop them around the bullet connector and upper throttle cable from the previous step, making sure to secure the wire ties to both sides of the bullet connector so that they are held in place. Trim to length.

28. Replace the air filter cover.

29. Attach the lower handle assembly with the two lower handle bolts.

INSTALLATION INSTRUCTIONS

Step 25

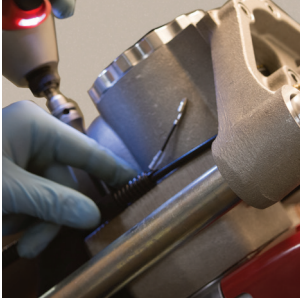

Step 26

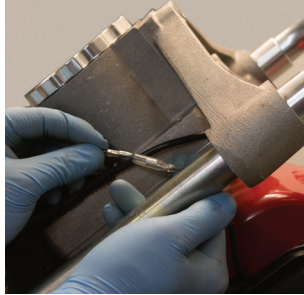

Step 27



Step 28



Step 29*

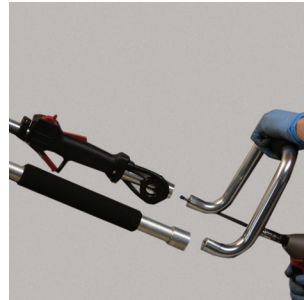

*** Please note you will need to order a lower handle (Part no. 301233) if your Pro-Series Driver model does NOT already have one. DO NOT OPERATE EXTENDED HANDLES WITHOUT A CONNECTING LOWER HANDLE.**



RHINO® EXTENDED HANDLE PARTS LIST

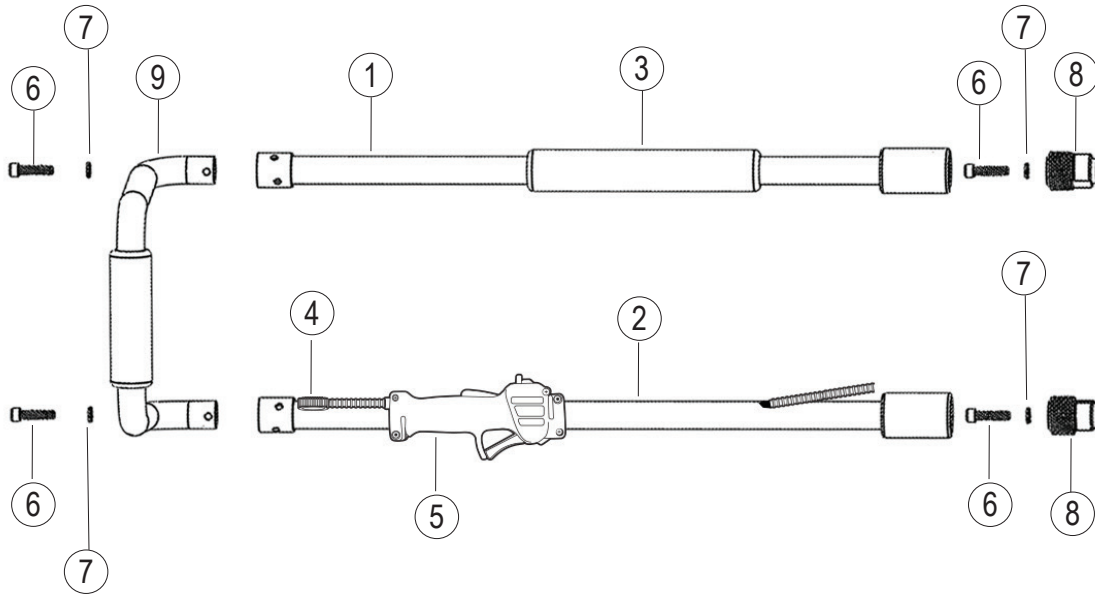

RHINO® EXTENDED HANDLE PARTS LIST

No.	P/N	Description
INCLUDED WITH EXTENDED HANDLES		
1	301259	GPD Extended Handle - 24"
2	301267	GPD Extended Handle - Slotted 24"
	301260	GPD Extended Handle - 54"
	301261	GPD Extended Handle - Slotted 54"
3	300221	8" (203 mm) EPDM Foam Grip (1 per kit)
4	301268	Extended Handle Cable Thimble
5	301262	Throttle Control Assembly for 2' Extended Handle
	301264	Throttle Control Assembly for 4 1/2" Extended Handle
	301275	Extended Handle Warning Label- Protection
	301276	Extended Handle Warning Label - Balance
	301277	Extended Handle Installation Instructions
	995032-3	6" Cable Tie (3 per kit)
	301270	Extended Handle Hardware Kit

No.	P/N	Description
301270 INCLUDED WITH EXTENDED HANDLE HARDWARE KIT		
6	300715-4	Bolt (4 per kit)
7	300750-4	Multi-Pro Lock Washer (4 per kit)
8	301255-2	Extended Handle Adapter (2 per kit)

No.	P/N	Bolt Torque Specifications
3	300715-4	Bolt (4 per driver) - 132.0 in/lbs (14.91 Nm)

No.	P/N	Description
OPTIONAL PARTS		
9	301233	Lower Handle Assembly*
		<i>*Only needed if your Pro-Series Model does not have a lower handle.</i>

Rhino® Limited Lifetime Impact Warranty Gasoline Powered Post Drivers



Warranty: Rhino Tool Company, Inc. (“Rhino”) warrants to the original purchaser, purchasing the Equipment in new condition, in original packaging from an authorized dealer that its Gasoline Powered Post Driver will be free from defects in workmanship and materials (the “Limited Warranty”). The Limited Warranty shall survive for the lifetime

of the product with respect to the Hammer and Anvil components and for twelve (12) months with regard to all other components, excluding the Honda GX35 engine for which Rhino provides no warranty and for which the warranty provided by American Honda Motor Co., Inc. shall be the sole warranty applicable thereto. This Limited Warranty is non-transferable.

For Warranty Claims contact your dealer or distributor. Proof of purchase date and serial number is required. In the event of a warranty repair, the post driver should be returned to a Registered and Warranty Authorized Rhino Servicing Dealer. Rhino’s obligation under this Limited Warranty is expressly limited to the repair or replacement, at Rhino’s election, of such defective Gasoline Powered Post Driver, which is proved to be defective upon inspection by a Rhino-certified/authorized technician.

This Limited Warranty does not extend to a Gasoline Powered Post Driver which has been subject to misuse, neglect, or accident, nor does it extend to any Gasoline Powered Post Driver which has been repaired, altered, or serviced by unauthorized persons. This Limited Warranty does not cover any damage or adjustments required to any Gasoline Powered Post Driver if such damage or adjustment is caused by the use of supplies, parts, or attachments not sold or approved by Rhino

EXCEPT AS OTHERWISE PROVIDED HEREIN, RHINO DISCLAIMS ALL OTHER WARRANTIES, EXPRESS OR IMPLIED, INCLUDING, BUT NOT LIMITED TO THE IMPLIED WARRANTIES OF MERCHANTABILITY AND FITNESS FOR A PARTICULAR PURPOSE. UNDER NO CIRCUMSTANCES SHALL RHINO BE LIABLE FOR ANY LOSS OF BUSINESS, REVENUES, OR PROFIT OR OTHER INDIRECT, INCIDENTAL, SPECIAL OR CONSEQUENTIAL DAMAGES OR LOSS ARISING OUT OF ANY DEFECTS IN OR PERFORMANCE OF THE GASOLINE POWERED POST DRIVER, HOWSOEVER CAUSED.

To register your product:

Fill out and mail in registration card supplied with post driver

Or online visit:

<http://rhinotool.com/contact-support/warranty-information/>



A TRADITION OF QUALITY AND SERVICE SINCE 1975

WWW.RHINOTOOL.COM

Form 301277.103117

Rhino Tool Company, Inc. | P.O. Box 111 | Kewanee, IL 61443 | 309.853.5555 | 866-707-1808